



Main applications

- Pressure controls on extrusion and injection press lines for plastics
- Differential pressure control
- Strength control on textile, paper, plastic film production lines
- Tension control on winding stations

Main characteristics

- Double configurable input for strain gauge / potentiometer / linear signal / TC / RTD
- Two auxiliary analog inputs
- Differential measurement
- High precision: 0.1 % f.s. \pm 1 digit
- Automatic calibration for 6-wire strain gauge
- Transmitter power supply and strain gauge probe power supply
- PID controls with 8 sets of selectable parameters
- 4 configurable alarms, failsafe function
- up to 3 isolated analog outputs for control and retransmission
- 4 digital inputs
- 4 relay outputs with configurable function
- expansion with 4 configurable digital inputs and/or outputs
- Serial communication interface:
 - RS485/RS 232 MODBUS RTU protocol (optional)
 - Profibus DP Slave (optional)
- Front panel with three 5-digit displays and two bar graphs

PROFILE

Single-loop microprocessor controller, 96 x 96 (1/4 DIN) format, appropriate for processes with high variation speed.

Thanks to its extended functions and configurable hardware and software, it provides high applicative flexibility in systems that control and monitor pressure, force, temperature, and differential pressure, and can acquire up to 4 variables.

It has two main analog inputs, configurable for strain gauge / potentiometer / linear signal / TC / RTD (one of which is optional) and two auxiliary analog inputs for linear signals (for example, remote setpoint functions and line speed reference input).

Two isolated analog outputs (one of which is optional) are available for control.

The operator interface, with IP54 protection level (IP65 with protective cover) is equipped with a 6-key soft-touch keyboard, triple 5-digit display (one of which is 2-color), and two bar graphs with configurable function.

Controls and commands can be sent from the front panel or via 4 digital inputs that can be assigned functions such as reset, calibration, man/auto, loc/rem, hold, raise/lower (motopotentiometer function), parameter set selection, setpoint selection.

The instrument has 4 configurable relay

outputs as standard.

More extended configurations are available with the following options:

- isolated analog output for retransmission of process, peak, remote set, deviation, alarm setpoint, differential values
- expansion with 4 I/O
- communication interface Modbus RTU
- communication interface Profibus DP (slave)

CONTROLLER

Self-adapting PI control or double-action PID (heating/cooling), ratio controller, differential pressure controller, selftuning, continuous or one-shot autotuning, Auto/man, Loc/rem, setpoint gradient, power gradient, dynamic power limits. 8 sets of selectable PID parameters based on setpoint level / PV / deviation or from digital inputs.

ALARMS

4 completely configurable alarm setpoints.

Selectable "failsafe" function.

MATH FUNCTIONS

The 2500 controller lets you define two distinct math relations between two analog inputs.

The results can be freely used as setpoints, alarm setpoints, control output, etc...

DIGITAL COMMUNICATION

The instrument offers an optional RS485 2/4 wire / RS232 serial interface with MODBUS RTU protocol for access to instrument parameters.

CONFIGURATION

The programming procedure is facilitated by the menu structure, with various configuration levels for quick and simple data search.

TECHNICAL DATA

OPERATOR INTERFACE

Display: n. 3

Configurable from -19999 to 99999 with settable decimal point
5 digits, 2 colors (R/G) 13mm
5 digits (G) 10mm
5 digits (G) 10mm

Bargraph: n. 2

with 10/20 red LEDs

Signal LEDs: n. 5 red

Keys: n. 6

ANALOG INPUTS

Accuracy:

0,1% f.s. ± 1 digit (0,2% for TC)

Min. sampling time:

2 msec for main inputs

10msec for auxiliary inputs

Resolution:

• without filter: 100000 steps@2msec

• with digital filter (selectable):

100000 steps@20msec

100000 steps@100msec (50Hz)

Custom linearization:

• fixed intervals: 64 sections

• variable intervals: 32 section max.

• self-learning

INPUT 1, INPUT 2 main inputs

Strain-gauge: 350 Ω

Sensitivity 1,5...4mV/V

Jumper power supply: 5/10Vdc 200mA

Potentiometer:

$\geq 100\Omega$, $R_i > 10M\Omega$ @ 2,5Vdc

Linear DC:

$\pm 50mV$... $\pm 10V$, $R_i > 1M\Omega$

0/4...20mA, $R_i = 50\Omega$

TC - Thermocouple

J 0...1000°C / 32...1832°F

K 0...1300°C / 32...2372°F

R 0...1750°C / 32...3182°F

S 0...1750°C / 32...3182°F

T -200...400°C / -328...752°F

custom -1999...9999

RTD 2/3-wires

PT100 -200...850°C / -328...1562°F

int./ext. cold junction compensation

INPUT 3 (auxiliary)

Linear DC: 0...10V, 0/4...20mA, $R_i = 50\Omega$

INPUT 4 (auxiliary)

Linear DC: 0...10V, 0/4...20mA, $R_i = 50\Omega$

DIGITAL INPUTS

4 NPN/PNP inputs

Optically isolated 1500V

NPN (voltage-free contact)

PNP 24Vdc max 5mA

configurable type and function

DIGITAL EXPANSION I/O(OPT.)

4 PNP inputs and/or outputs

Isolated external power supply 24Vdc, $\pm 25\%$

Input 24Vdc, 5mA

PNP output in external power supply

range, with short circuit protection via

PTC, max. 100mA.

ANALOG OUTPUTS

3 isolated outputs 1500V

0/4...20mA, max 500 Ω or

$\pm 10V$, min 500 Ω

resolution higher than 0,03%

configurable type and function

Control **OUT CO1**

Control **OUT CO2** (optional)

Retransmission **OUT W** (optional)

Not available with option of Profibus communication

RELAY OUTPUTS

4 relay outputs

NO/NC contact (internally selectable)

5A/250Vac $\cos\phi = 1$

configurable function

OUT1, OU2 with terminal C in common

OUT3, OU4 with terminal C in common

COMMUNICATION (OPT.)

Serial interface:

RS485 2/4-wires / **RS232** optically isolated

Protocol: MODBUS RTU

Profibus DP slave

Protocol: Profibus DP VO (slave)

CONFIGURATION VIA PC

TTL service interface, connectable to PC

via "Winstrum" kit

CONNECTIONS

screws

POWER SUPPLY

100...240Vac/dc $\pm 10\%$,

20...27Vac/dc $\pm 10\%$,

50/60Hz; 20VA max

Protection via internal fuse, not replaceable by operator.

PROBE POWER SUPPLY

5/10Vdc - 200mA, 2,5Vdc for potentiometers

TRANSMITTER POWER SUPPLY

24Vdc $\pm 5\%$ - 100mA

WEIGHT

700g

DIMENSIONS

96x96x167mm

ACCESSORIES

Front covers

standard Gefran (see catalog)

Winstrum Kit

TTL/RS232 interface wires + CD ROM

DESCRIPTION FACEPLATE

A - Process variable display, digit height 13 mm, 2-color (green/red)

B - C - Data display, digit height 10 mm, green

D - Control output percentage indicator (red)

E - "FUNCTION" button

F - "LOWER" button

G - "RAISE" button

H - "MAN/AUTO" button

I - "CAL-RST" button

L - "PEAK" button

M - Alarm setpoint signals, MANR, REM, CAL, red LEDs

N - Deviation indicator, red LEDs

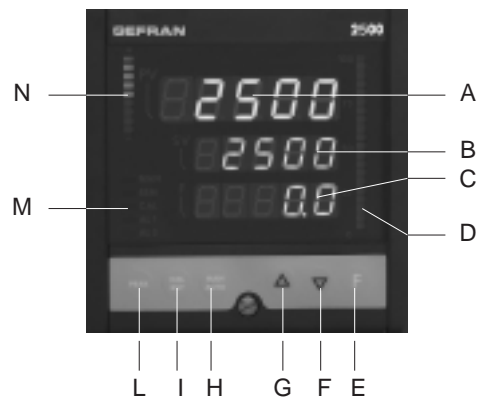

IP54 front panel protection (IP65 available)

CONNECTION DIAGRAMS

Model with single main input Model: 2500 - 0 - X - X - X - X - X

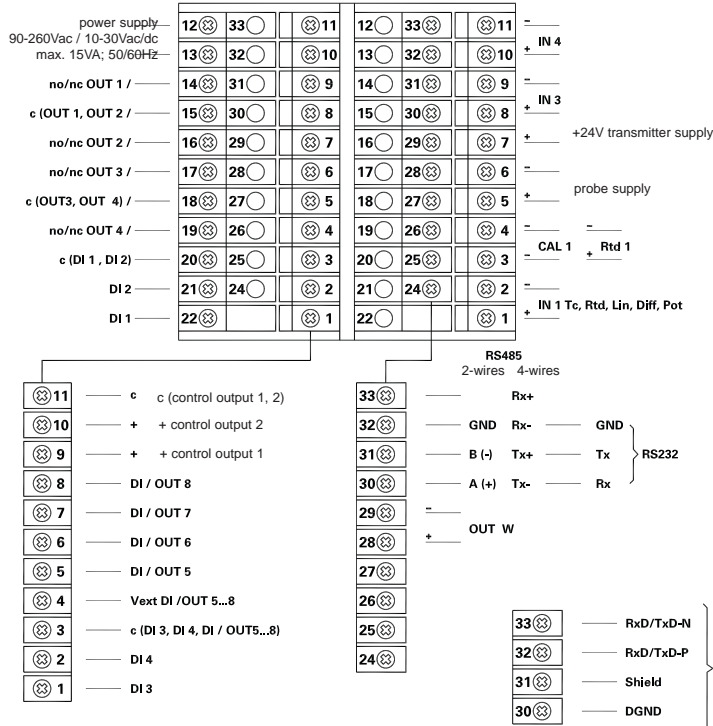

Strain-gauge

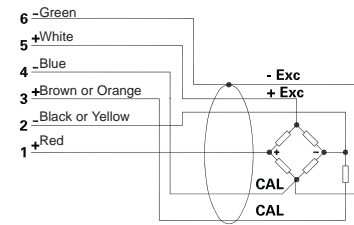

IN1

Input in current



Input in voltage



Thermocouple

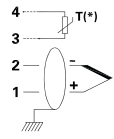

(*) PT100 for possible external cold junction compensation

Resistance Thermometer

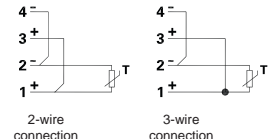

Potentiometer

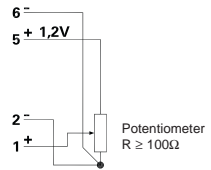

Model with double main input Model: 2500 - 1 - X - X - X - X - X

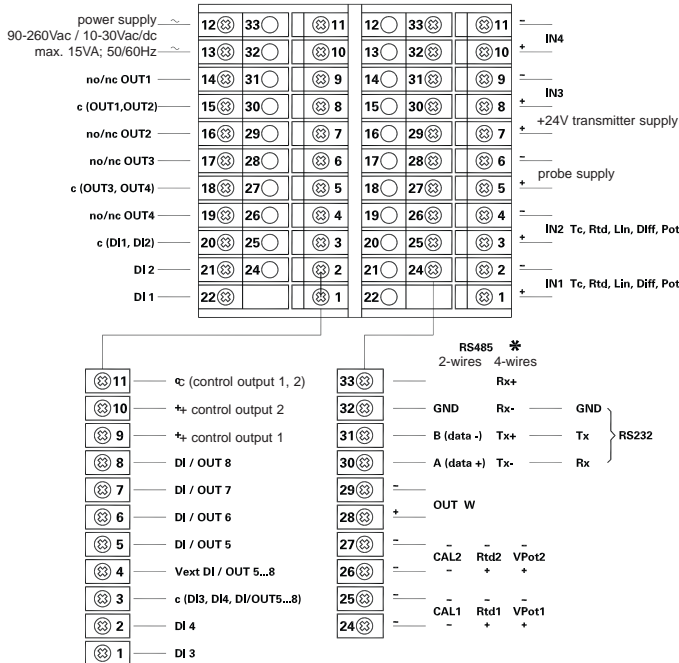

IN1

Strain-gauge

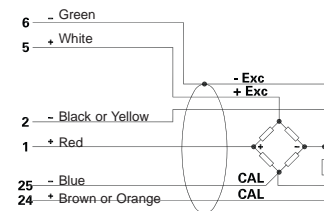

Input in current / voltage



Thermocouple

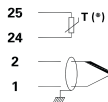

(*) PT100 for possible external cold junction compensation

Resistance Thermometer

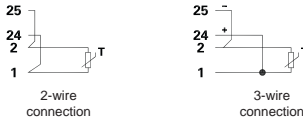

Potentiometer

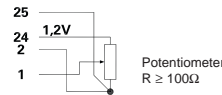

IN2

Strain-gauge

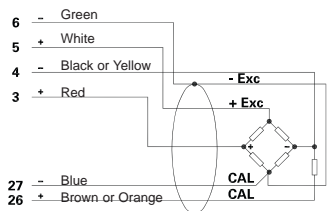

Input in current / voltage



Thermocouple

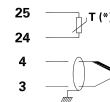

(*) PT100 for possible external cold junction compensation

Resistance Thermometer

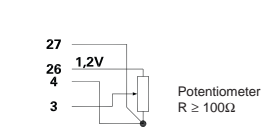
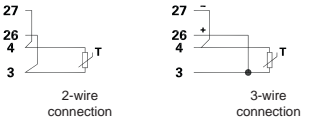

* For Profibus connections, please refer to single input model



Apply user's manual warnings for a correct installation

DIMENSIONS AND CUT OUT

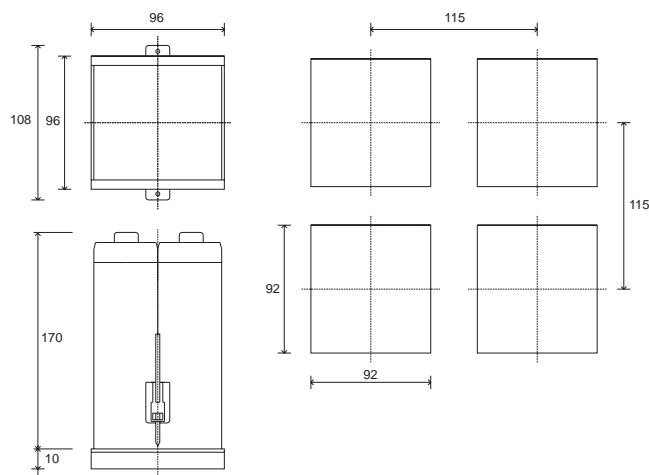

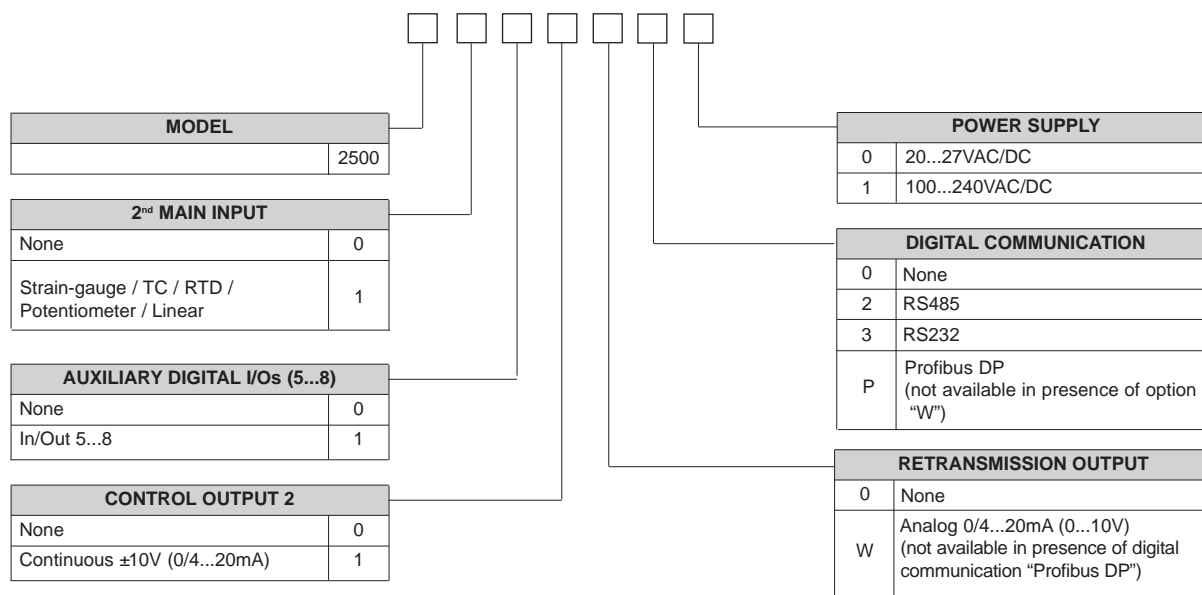

Dimensions: 96x96mm (1/4 DIN), depth 167mm

ORDER CODE



Please, contact GEFRA sales people for the codes availability.

GEFRAN spa reserves the right to make any kind of design or functional modification at any moment without prior notice.

	Conformity C/UL/US File no. E216851
	In conformity to ECC 89/336/CEE and 73/23/CEE with reference to standards: EN 61000-6-2 (immunity in industrial environment) - EN 61000-6-3 (emission in residential environment) - EN 61010-1 (safety)