



## Main applications

- Supervision of industrial processes
- Gateway between field and mainframe
- Application in critical environments
- Data centralization
- Human-machine interface (HMI)
- Control of machines and systems
- Data display

## Main features

- 10.4", 12.1", 15" TFT Display
- High performance
- Large SSD
- Modular configuration
- Connectivity
- Easy access and maintenance
- Reduced depth
- No internal wires

## FEATURES

*DIGISTAR II is an industrial PC with configuration and resource management and display functions.*

*This version enhances the typical functions of PC architecture in a compact frame.*

*DIGISTAR II can be used in numerous industrial applications, from machine control units to data centralization system, from system supervisor to traditional human-machine interface (HMI).*

*DIGISTAR II has a TFT display (10.4", 12.1", 15") and can be equipped with a resistive touch screen.*

*This version uses Intel Mobile class processors; such as the Celeron™ 600 MHz, Celeron 1500 MHz or Pentium 1800 MHz, which efficiently manages heat dissipation in order to limit use of the PC cooling fan.*

*Use of the Windows XP Embedded operating system permits the use of DOM for Win-Based applications.*

*DIGISTAR II can be fit with a DOM-type solid state mass storage or a 2.5" HD for*

*better configuration, depending on the application and operating system used.*

*Thanks to the complete series of available ports (Ethernet, USB, serials, parallel, PS/2 etc.), DIGISTAR II can link to various peripherals commonly utilized in the industrial field.*

*Maximum connectivity is achieved by adding optional custom interfaces and standard PCI, PC104.*

*Available interfaces include: RS422/485 serial expansions and additional Ethernet channels.*

*A number of functions, Management of control keyboard I, LED, and switch-on logic output with programmable timer, these are typical of this version for the control of machines or industrial lines. Careful construction and mechanical design make it easy to install and give correct access to expansions. Simple maintenance guarantees long life and reliability.*

## TECHNICAL DATA

### CPU

- Intel Pentium Celeron™ 600 MHz (2Mb Cache L2)
- Intel Celeron Mobile™ 1500 MHz (2Mb Cache L2)
- Intel Pentium Mobile™ 1800 MHz (2Mb Cache L2)

### CHIPSET

- Intel™ 852GM, 400 MHz FSB

### VIDEO CONTROLLER

- Intel™ Extreme Graphics 2 Controller (up to 64MB DRAM Video)

### DISPLAY

- 10.4" color TFT 800x600 pixel 262K col.; angle of view 120°/100° H/V contrast 500:1, Luminosity 230 cd/m<sup>2</sup>
- 12.1" color TFT ris. 800x600 pixel 262K Col. angle of view 140/110 H/V, contrast 500:1, Luminosity 600 cd/m<sup>2</sup>
- 15" color TFT ris. 1024x768 pixel 262K col. angle of view 130°/120° H/V contrast 500:1, Luminosity 350 cd/m<sup>2</sup>

#### DYNAMIC RAM

- DDR 256MB, 512MB, 1GB

#### STATIC RAM

- 256Kb with lithium backup battery

#### MASS STORAGE

##### SSD

- DOM 1Gb, 2Gb, 4Gb

##### Magnetic

- HDD 2.5" IDE optional
- FDD optional  
(to connect to specific port)

#### I/O PORTS

- 1 serial port RS 232  
+ 1 RS232/RS422/RS485
- 2 USB ports 2.0
- 1 Ethernet port RJ45 10/100 Mbps
- 1 VGA port for external monitor
- PS/2 port for keyboard and mouse
- Centronics parallel port
- Synchronous serial port for matrix control max 128 keys and 64 LEDs
- Connector for external battery

#### EXPANSIONS

- 1 PCI slot
- 1 PC104 slot 16 bit max. 3 boards
- 4 special slots for optional interfaces

#### OPTIONAL INTERFACES

- GT-SER2 module:  
2 serial ports COM3, COM4,  
2xRS232/RS422/RS485 optically  
isolated

#### COM4 is not available if a touch screen is installed.

- GT-ETH1 module:  
1 Ethernet channel 10/100 Mbps  
Ethernet controller Intel 82551ER
- GT-ETH2 module;  
2 Ethernet channels Ethernet  
controller Intel 82551ER (see specific  
documents)

#### KEYBOARDS AND CURSORS

- 10 front-panel function keys, ENTER  
key and TAB (12.1" and 15")
- Optional 5-wire resistive touch
- Optional DIGITAST keyboard with  
optional mouse pad

#### DIAGNOSTICS

Front-panel LEDs with function indication  
Alarm and operating state LEDs

#### POWER SUPPLY

- 18..30Vdc 2.5 A max. with polarity  
protection and galvanic insulation

- Short circuit protection with resettable  
PTC.
- ON/OFF switch

#### OPERATING SYSTEMS

- Microsoft Windows XP Pro™ MUI Pack
- Microsoft Windows XP Embedded™  
in English

#### AMBIENT OPERATING CONDITIONS

- IP 65 front panel protection
- Operating temperature 0°C..+50°C
- Storage temperature -20°C..+70°C
- Humidity: 90% max., non-condensing

#### DIMENSIONS AND WEIGHTS

- With 10,4" display :  
309x239x117 mm - 4 Kg max
- With 12,1" display :  
335x295x117 mm - 5 Kg max
- With 15" display :  
395x340x117 mm - 7 Kg max

## FRONT PANEL

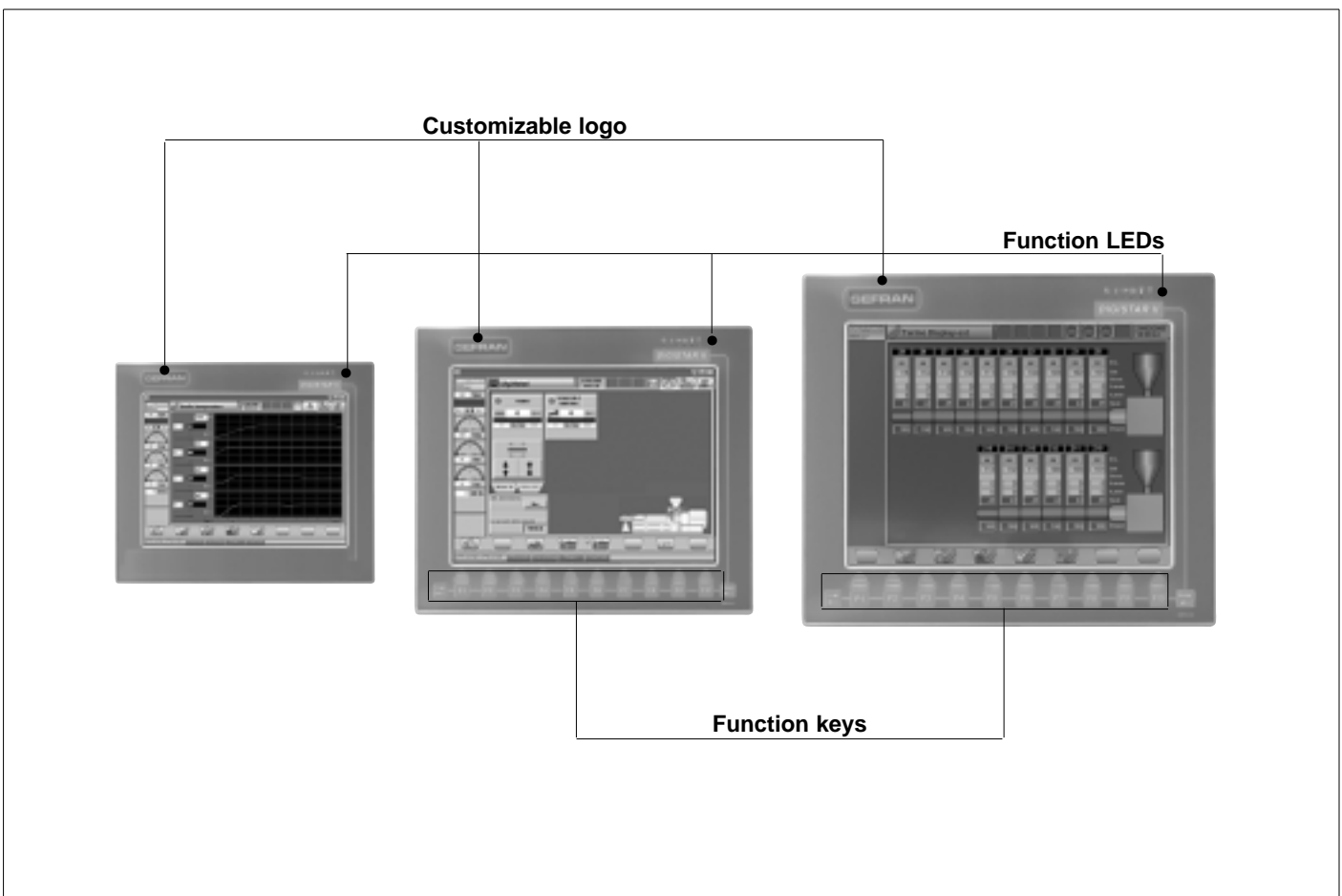

## CONNECTIONS and OPTIONS

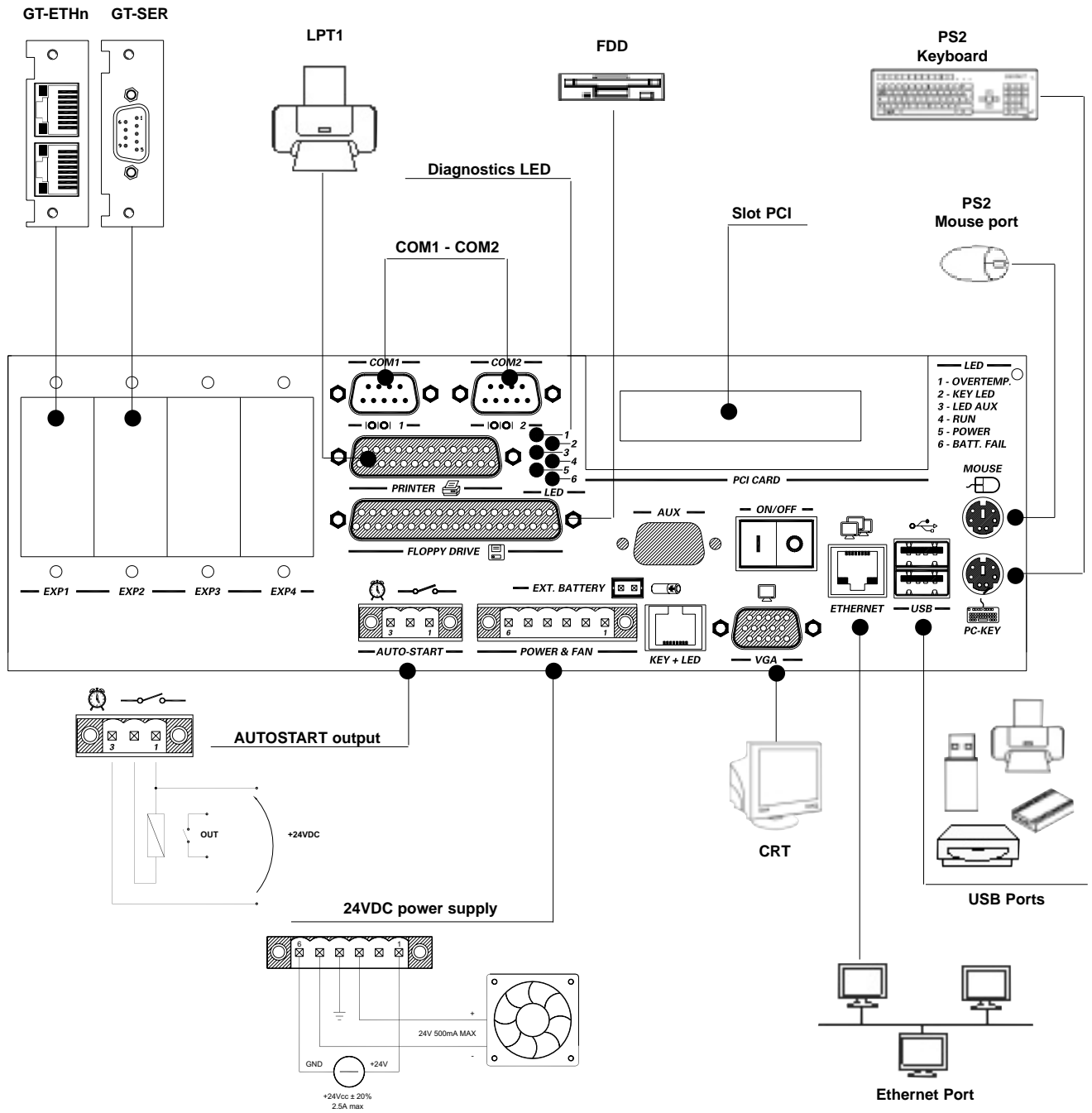

## INTERNAL VIEW AND CONFIGURATION OPTIONS

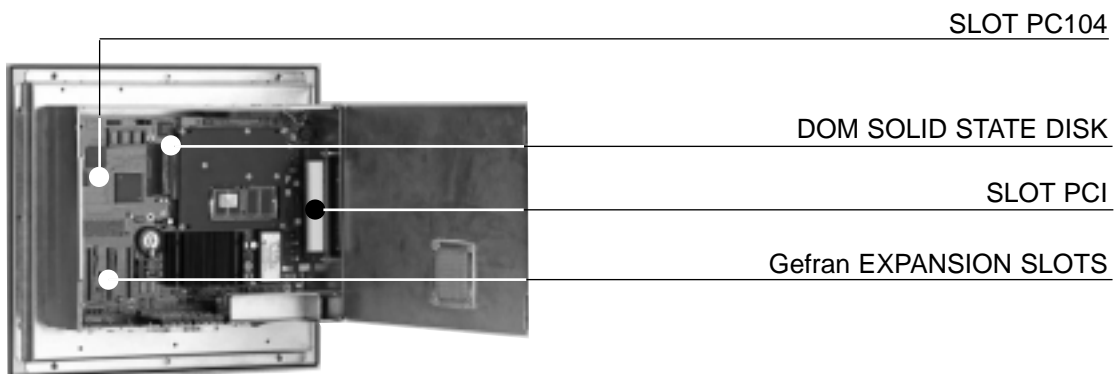

**MECHANICAL CHARACTERISTICS AND OVERALL DIMENSIONS**

**10.4" Version**

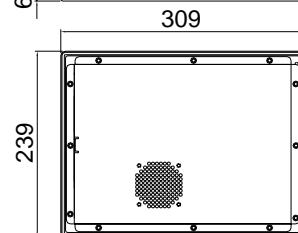
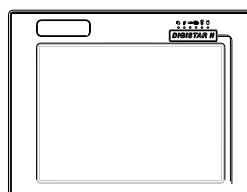
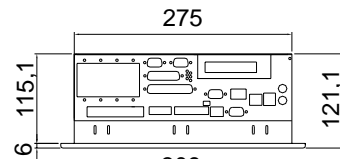
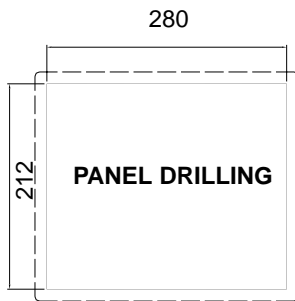
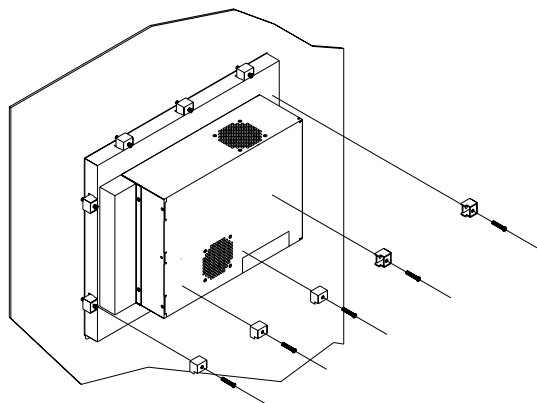

**12.1" Version**

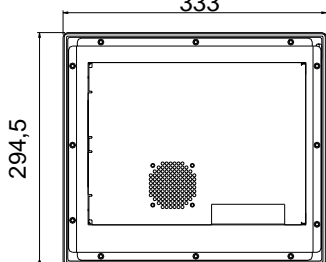
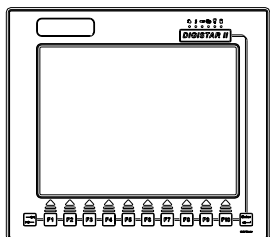
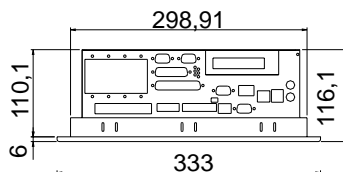
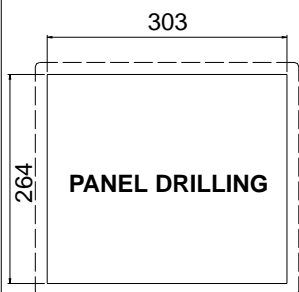

**15" Version**

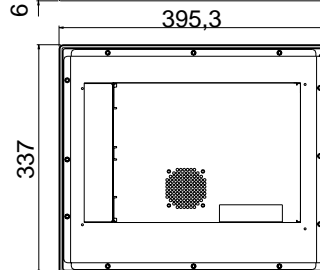
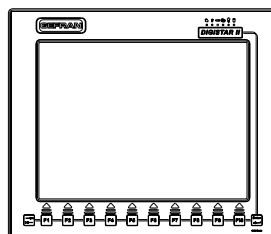
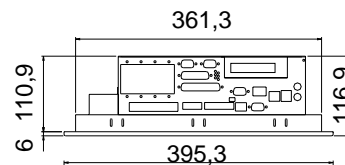
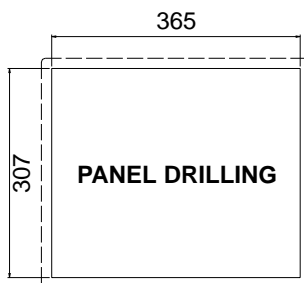

**Installation warnings**

DO NOT install the product in devices or boxes without adequate air circulation or heat exchange sufficient to maintain the temperature below 50°C.

When installing the product, be careful to position it so as to prevent accidental knocking.

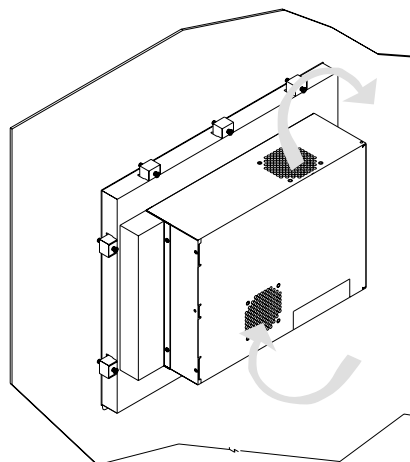

## ORDER CODE

	MOD	SO	μP	RAM	DOM	EXP1	EXP2	EXP3	EXP4
DGS II	-	-	-	-	-	-	-	-	-

MODEL	
10.4" color TFT 800x600	10
10.4" color TFT 800x600 + touch screen	10T
12.1" color TFT 800x600	12
12.1" color TFT 800x600 + touch screen	12T
15" color TFT 1024x768	15
15" color TFT 800x600 + touch screen	15T

OPERATING SYSTEM	
Rom-dos	00
Windows XP Pro MUI Pack™ (1)	XP
Windows XP embedded™	XE

PROCESSOR	
Intel Pentium Celeron™ 600 MHz	PCE
Intel Pentium Celeron Mobile™ 1500 MHz	PCS
Intel Pentium Mobile™ 1800 MHz	PCT

DRAM	
DDR 256 MB	R256
DDR 512 MB	R512
DDR 1024 MB	R1G0

DOM & HD	
DOM 1 Gb	D1G0
DOM 2 Gb	D2G0
DOM 4 Gb	D4G0
Hard Disk (2)	HD20

CUSTOM SLOT 4 EXPANSION	
00	none

CUSTOM SLOT 3 EXPANSION	
00	none

CUSTOM SLOT 2 EXPANSION	
00	none
SR	GT-SER 2 serial channels (3)



CUSTOM SLOT 1 EXPANSION	
00	none
E1	GT-ETH1: 1 Ethernet channel
E2	GT-ETH2 : 2 Ethernet channels

(1) Requires HD20 option  
 (2) Minimum hard disk capacity depends on market conditions  
 (3) Only 1 channel with touch screen

Kindly contact GEFTRAN for information on available codes.

GEFRAN spa reserves the right to make aesthetic or functional changes at any time and without notice

	Conformity UL508 File no. E198546
	In conformity to ECC 2004/108/CE (EMC) and 2006/95/CE (LVD) with reference to: <b>EN 61131-2</b> (product) <b>EN 61010-1</b> (safety).

# GEFRAN

GEFRAN spa via Sebina, 74 - 25050 Provaglio d'Iseo (BS)  
 Tel. 03098881 - fax 0309839063 - Internet: <http://www.gefran.com>

DTS\_DIGISTAR II\_0109\_ENG